

DragonROV

Intelligent Subsea Equipment

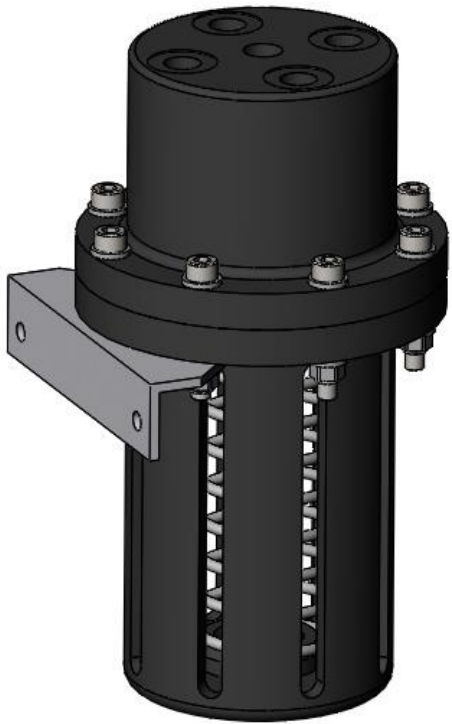

Description:

Rolling bladder type compensator for pressure balancing of subsea oil filled assemblies such as junction boxes, transformer housings, or motor bodies. Standard design manufactured from lightweight corrosion resistant Acetal for general purpose use.

Hydraulic Compensator 275cc version

MAIN FEATURES

- Corrosion resistant
- 275cc volume
- Compensates a volume of up to 5900cc
- Acetal body with rubber diaphragm and stainless steel spring

Further Information

Advanced spares kits also available

Equipment supplied

Standard supply includes

- 275cc compensator unit.
- Operating manual



info@DragonROV.com

Specifications

Weight in Air	1.9Kg
Weight in Sea water	0.4Kg

Options

- Aluminium, Stainless steel, and duplex versions available

Information contained in this data sheet is up-to-date and correct as at the date of issue. All product designs, specifications and data are subject to change without notice to improve reliability, function, design or otherwise. No express or implied warranties are given.